

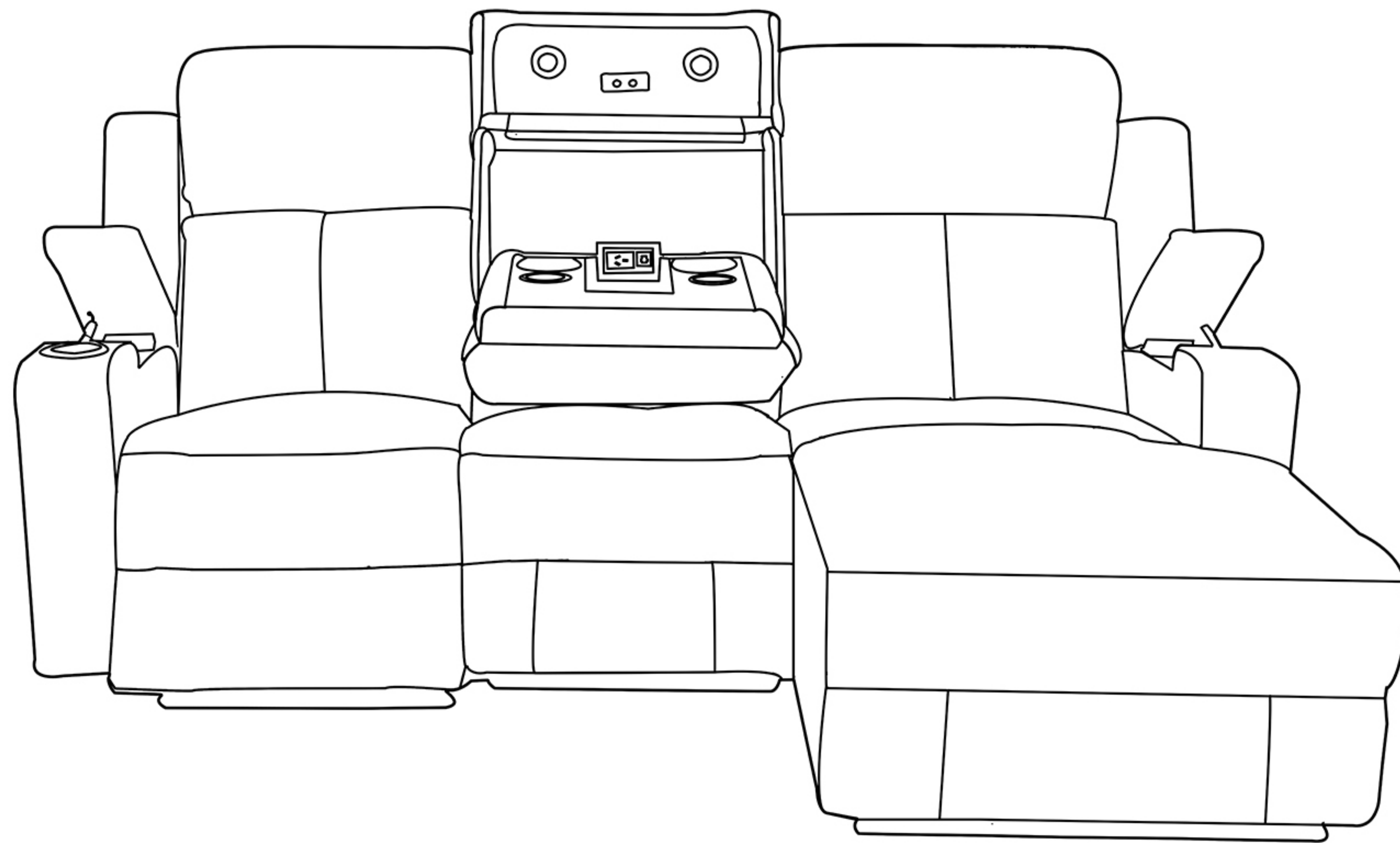

Assembly Instruction



Item Code-Xanadu(10172)

Imported By JCI Global
Building 3 west,605 Zillmere Rd.Aspley QLD 4035

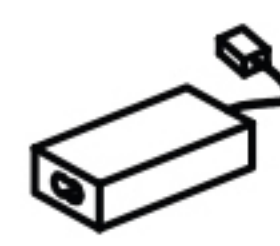

L1E+A1E-E Station+RECH

Power packs

| L1E+A1E-E Station+RECH | | | |
|------------------------|---|-------------|------|
| A |  | Transformer | 1PCS |
| B |  | Power Line | 1PCS |
| C |  | Y Cables | 2PCS |

BEFORE YOU START...

1. Choose a clean , level, spacious assembly area. Avoid hard surfaces that may damage the product.
2. Check and ensure that you have all required contents for complete assembly.
3. Always read the assembly instructions carefully before beginning assembly.
4. The packaging and contents can be a choking hazard, therefore keep out of reach of small children at all the times.

Step 1 Join the wings

Take out the wing from the bottom of the armrest, assemble it as above instruction.

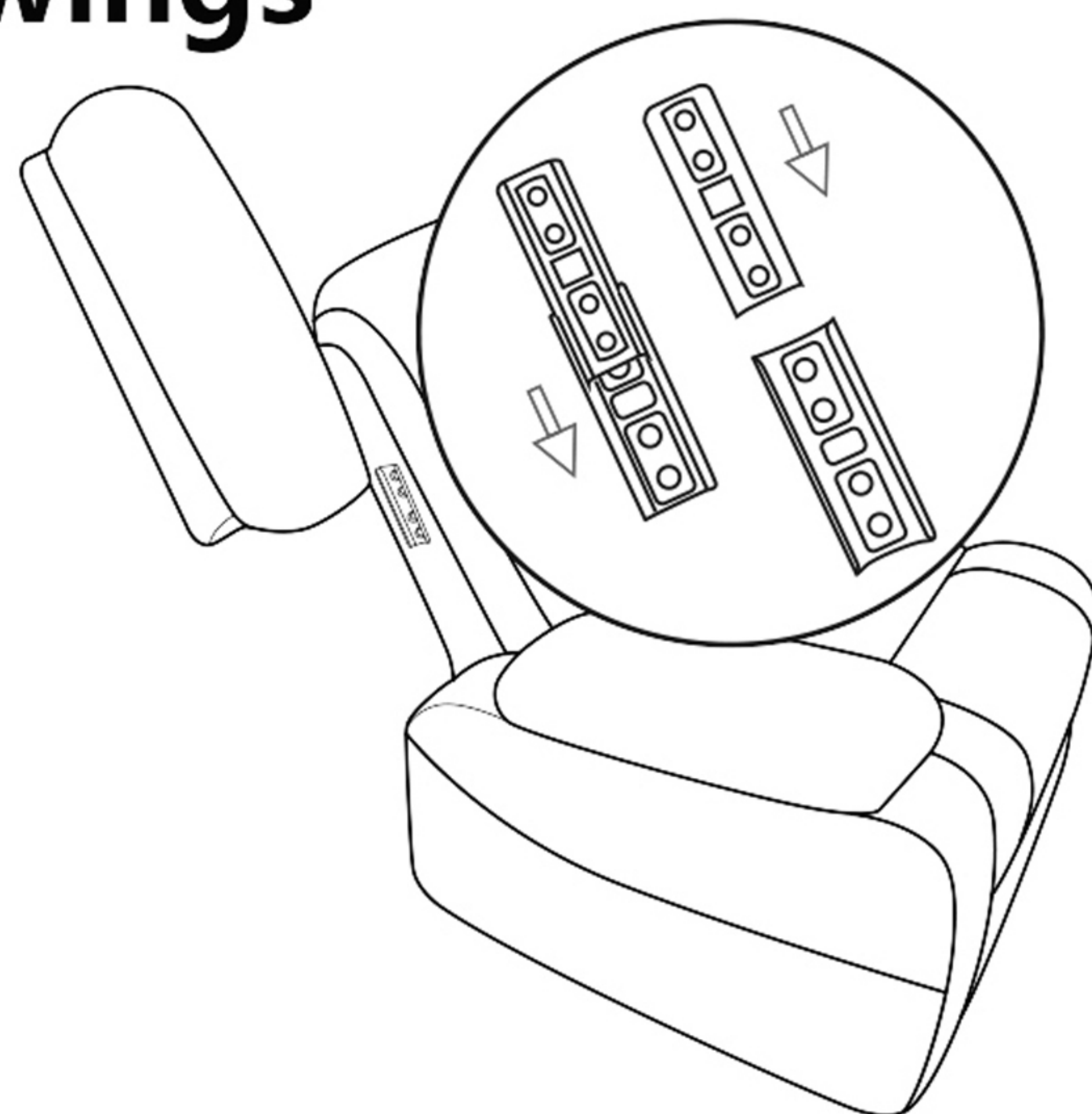

Step 2 Join sofa by back connector

Open the carton, take out the bag from the none-woven bag, connect the back to seat as below:

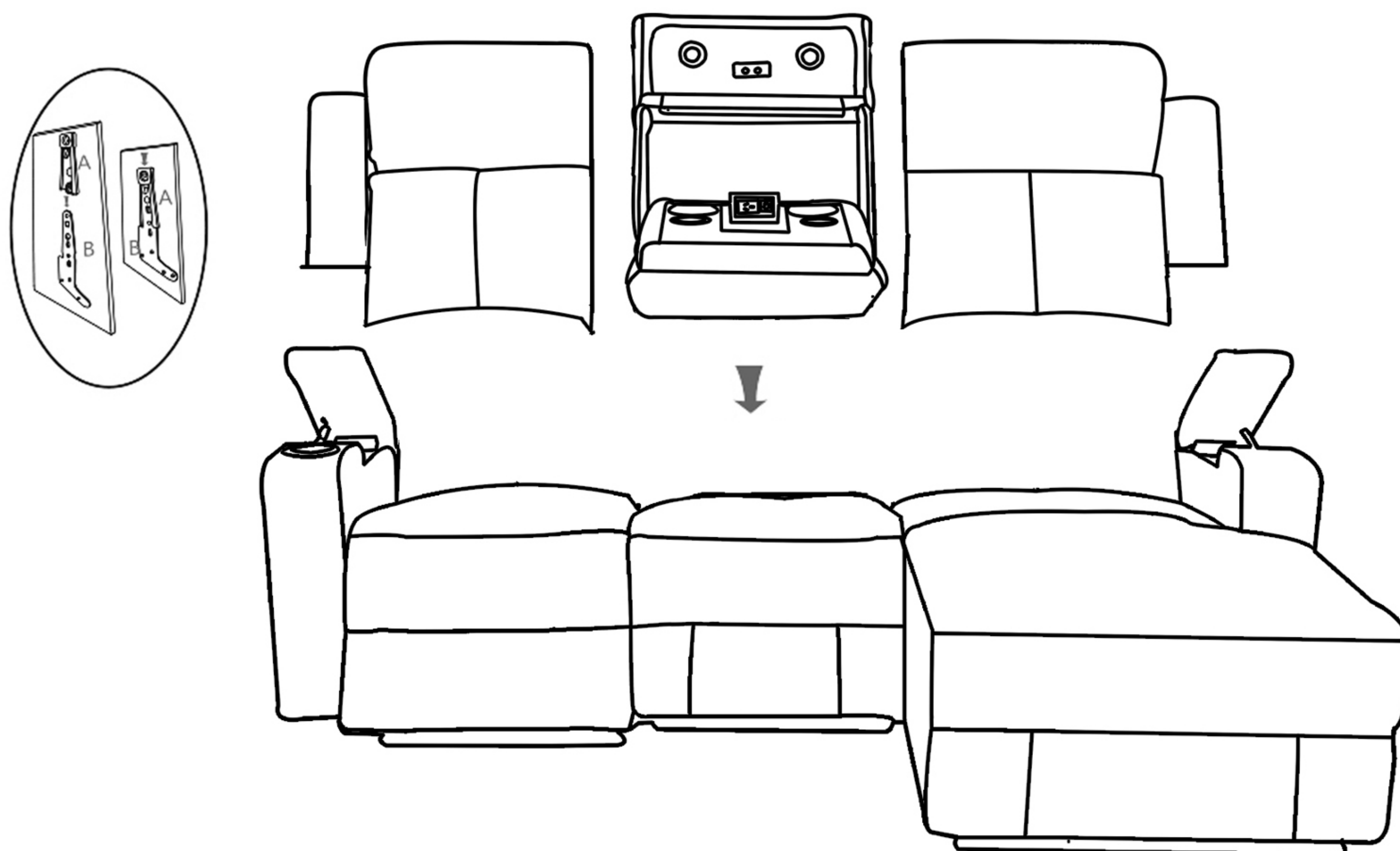

Step 3 Wire Connection

1. Headrest Motor connection, open the back flag of the seat, connect the parts as instructed;

2. Reading lamp connection, open the back flag of the middle seat, connect the parts as instructed;

3. Speaker and wireless charger connection, open the back flag of the middle seat, connect the parts as instructed;

4. Subwoofer connection, open the back flag of the middle seat, connect the parts as instructed;

5. Take out the electric parts from arm storage, connect them as instructed.

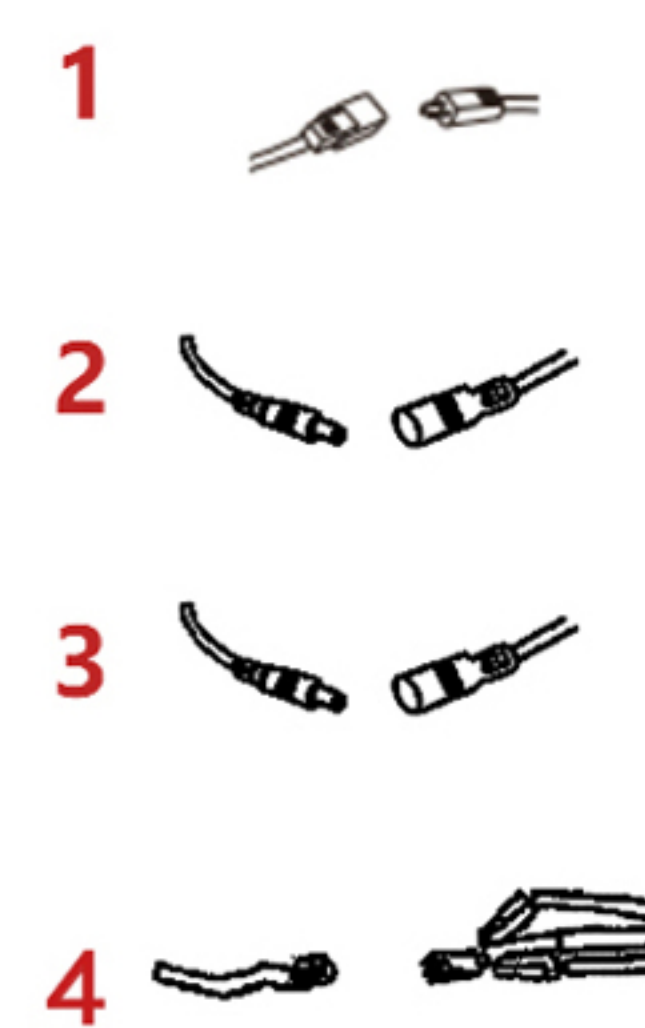
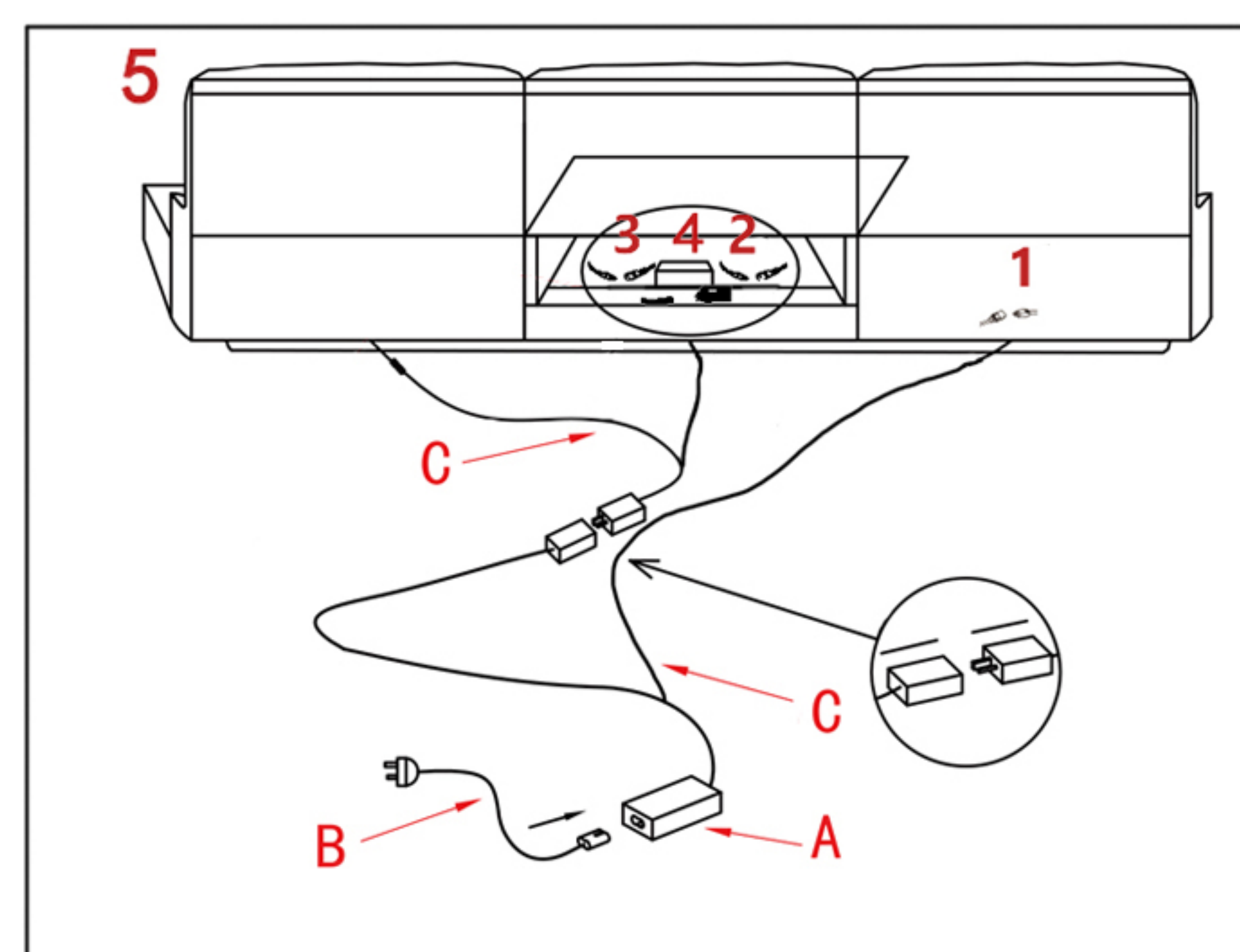

Function 1 : Socket outlet for the E-station

Press the Button to open the Socket outlet for the E-Station.

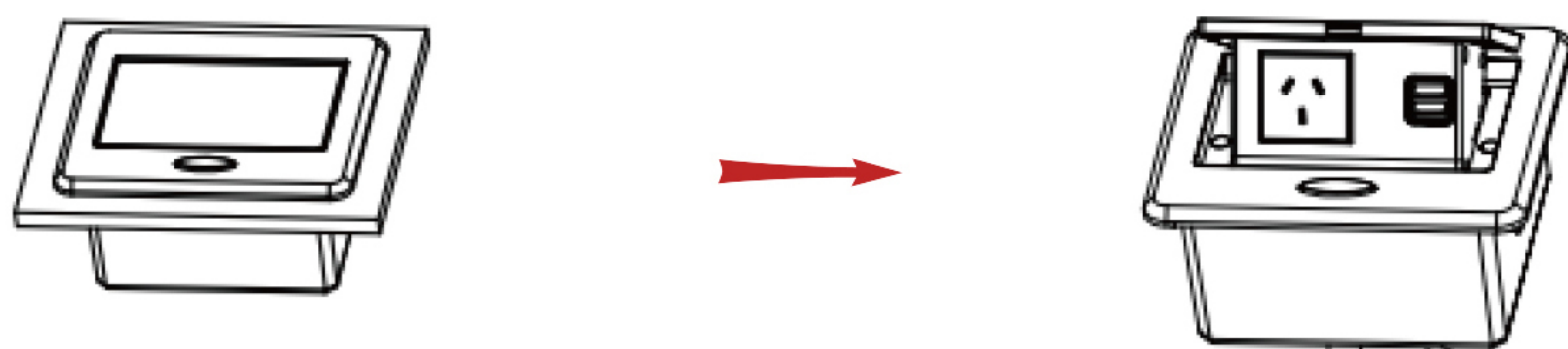

Function 2 : Reading Lamp

Touch the Light to control the luminance, all 3 grades

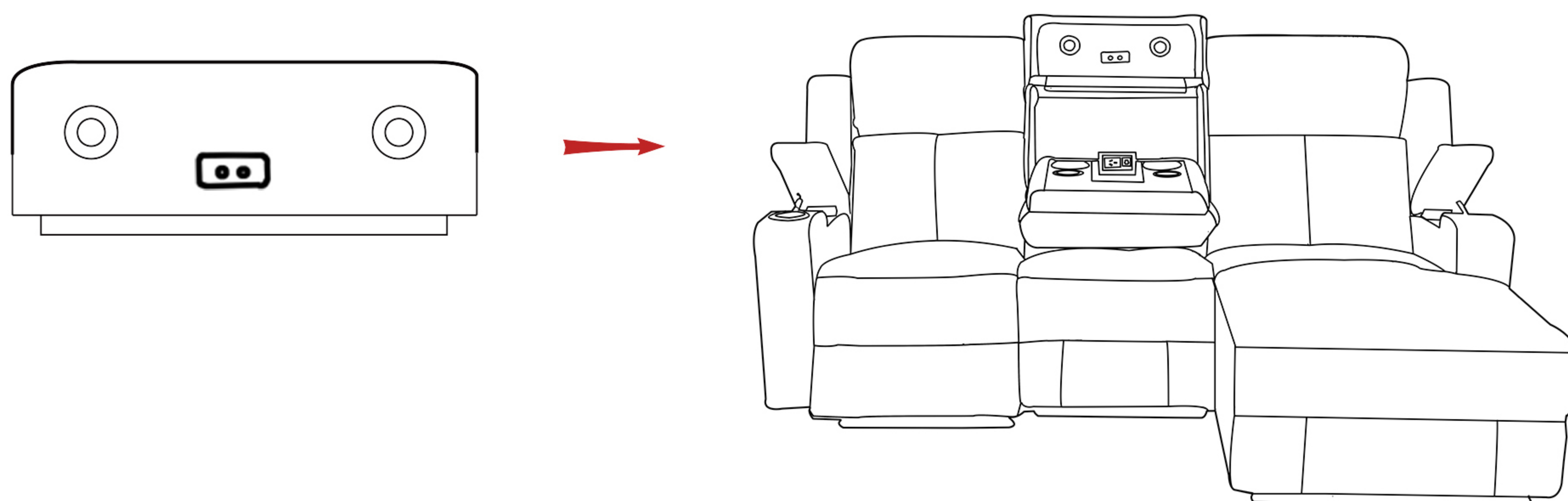

Function 3: Hand Switch

- 1) Recline
- 2) Back to sit position
- 3) Open the headrest
- 4) Close the headrest
- 5) USB Charger
- 6) Type-C Charger
- 7) Lighting controller

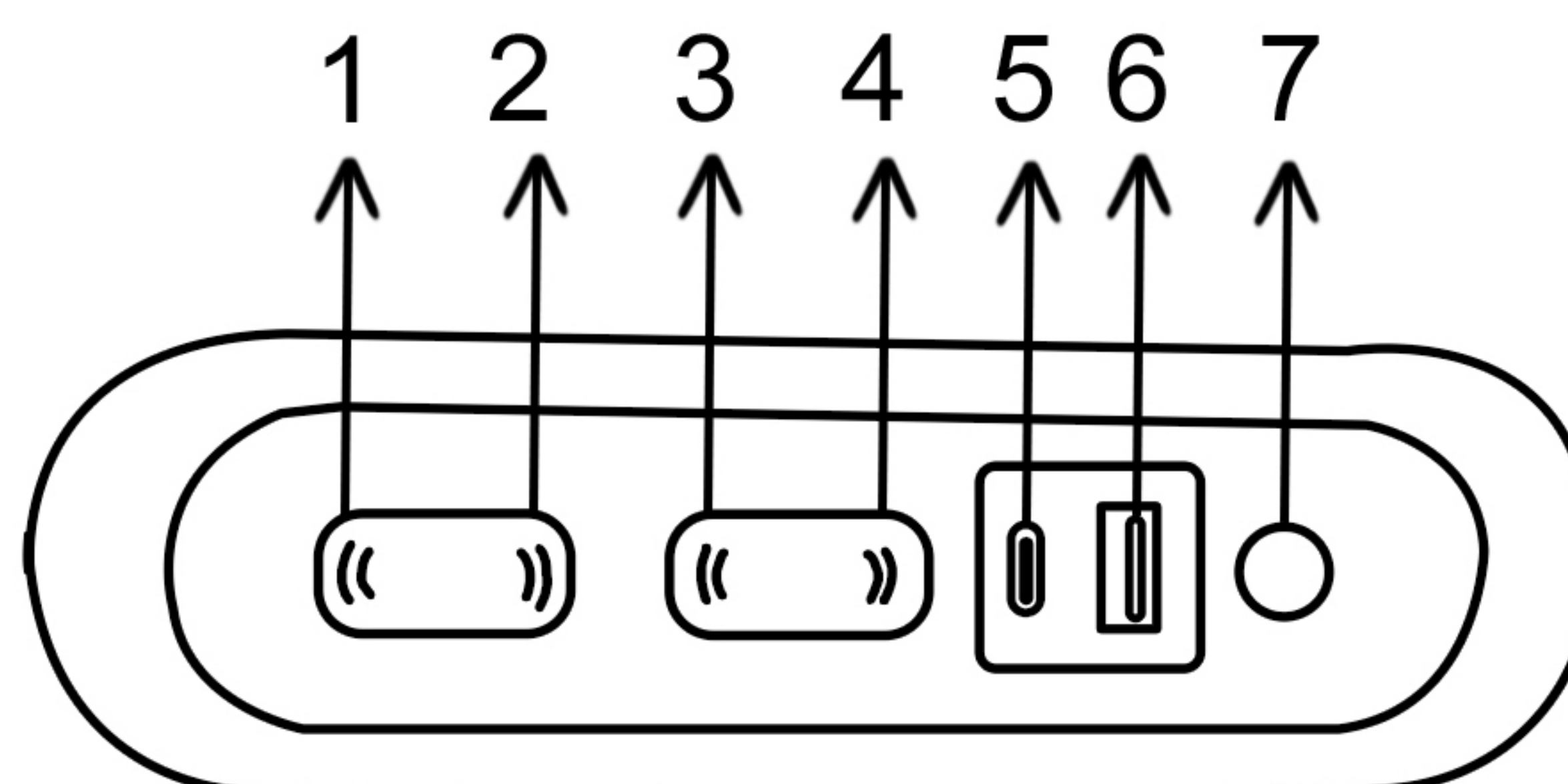

Function 4 : Wireless Charger

Put your mobile phone upon the part to charging

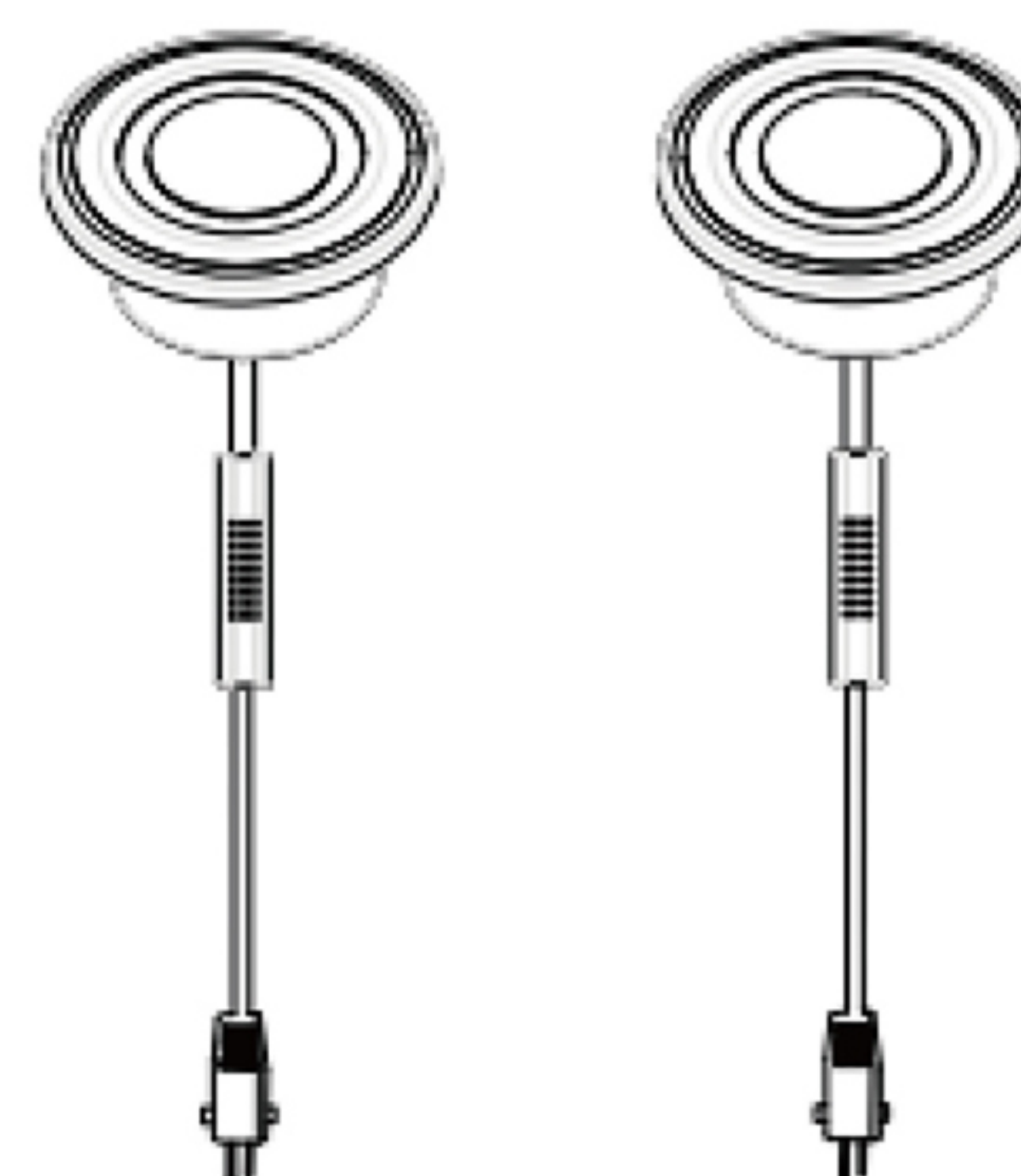

Function 5: Bluetooth Audio

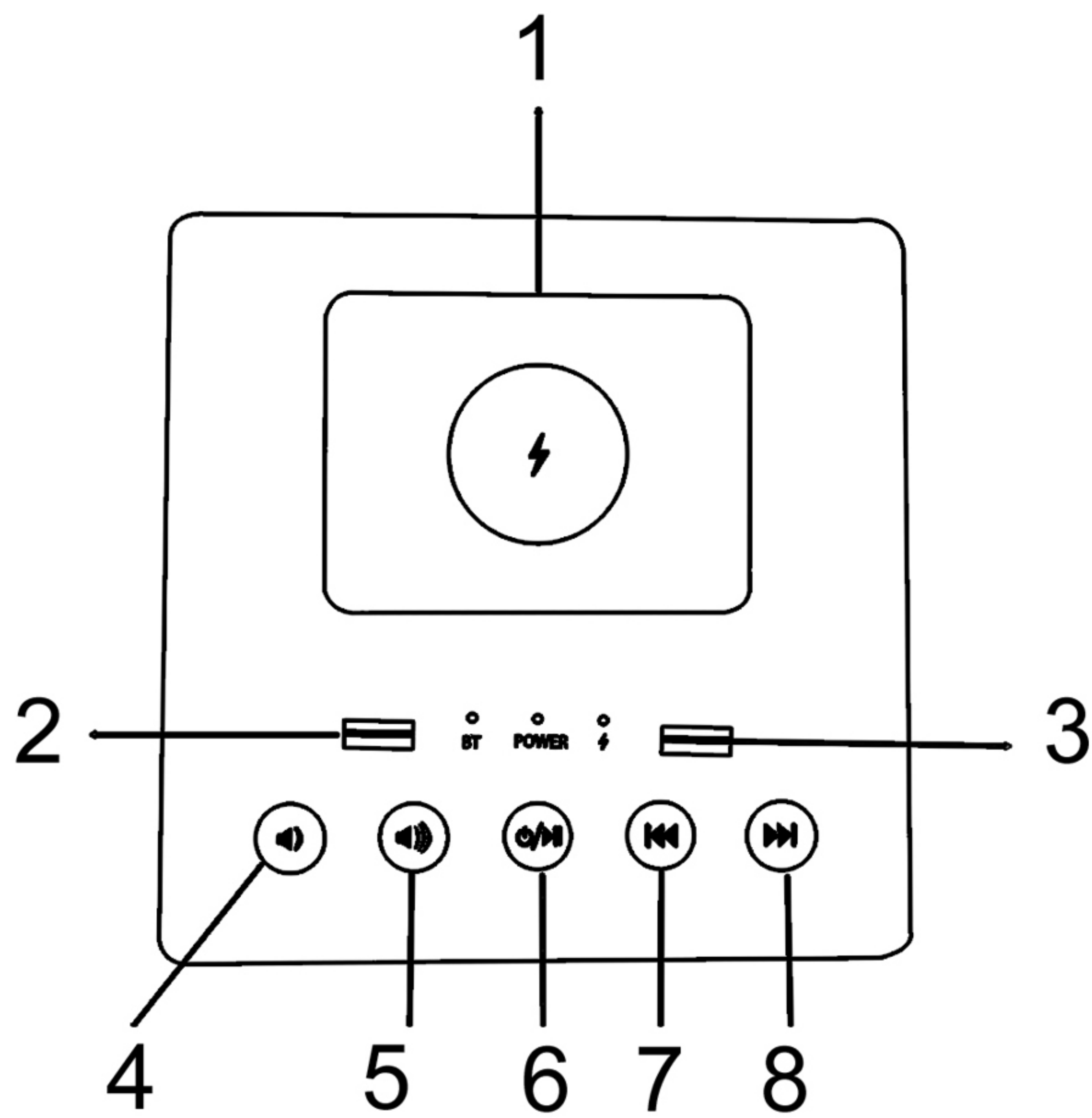

- 1)Wireless Charger
 - 2)USB Charger
 - 3)USB Charger
 - 4)Turn down the volume
 - 5)Turn up the volume
 - 6)On-off/ Pause
 - 7)Turn to the last song
 - 8)Turn to the next song
- Name of bluetooth device: MP05

This appliance is not intended for use by persons (including children) with reduced physical, sensory or mental capabilities, or lack of experience and knowledge, unless they have been given supervision or instruction concerning the use of the appliance by a person responsible for their safety. Children should be supervised to ensure that they do not play with the appliance.