











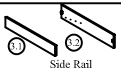









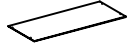









MODEL : CF 9442-A 6'

Parts List		
Parts	Description	Qty
1	Headboard 	1
2	Footboard 	1
3	Side Rail 	2
4	Side Rail Legs Wooden 115 x 70 x 50(H) 	2
5	Metal Centre Rail 2040mm 	1
6	Wooden Centre Rail 1490mm 	2
7	Support Leg 65mm 	4
8	Pump Mounting Bracket 	2

Parts	Description	Qty
9	Bracket Base 	2
10	Gas Spring 	2
11	Wooden Frame Bracket 	2
12	Wooden Frame (holes are not the same) 	1
13	Wooden Frame (holes are not the same) 	1
14	Bottom Panel 	3
15	Drawer Legs Wooden 35 x 45 x 50(H) 	2
16	Footboard Drawer 	1

Hardware List		
Parts	Description	Qty
A	M6 x 30 mm JCBC 	8
B	M6 x 40 mm JCBC 	18
C	M6 x 50 mm JCBC 	2
D	M8 x 60 mm JCBC 	8
E	M6 Spring Washer 	12
F	M6 Flat Washer 	22
G	M8 Spring Washer 	16
H	M8 Flat Washer 	16

Parts	Description	Qty
I	M8 Hex Nut 	8
J	M4 x 25 mm CSK 	8
K	Allen Key M4 x 100 mm 	1
L	Allen Key M5 x 70 mm 	1
M	M8 Spanner 	1
N	Small Adjuster 	4
O	M8 x 20 mm JCBB 	4
P	M4 x 32 mm CSK 	2

Step 1 : Attach the pump mounting bracket (8) and bracket base (9) to the both side rail (3) using hardware parts B , E , F and K. Attach the legs (4) to the footboard (3) using hardware parts (C) and (K).

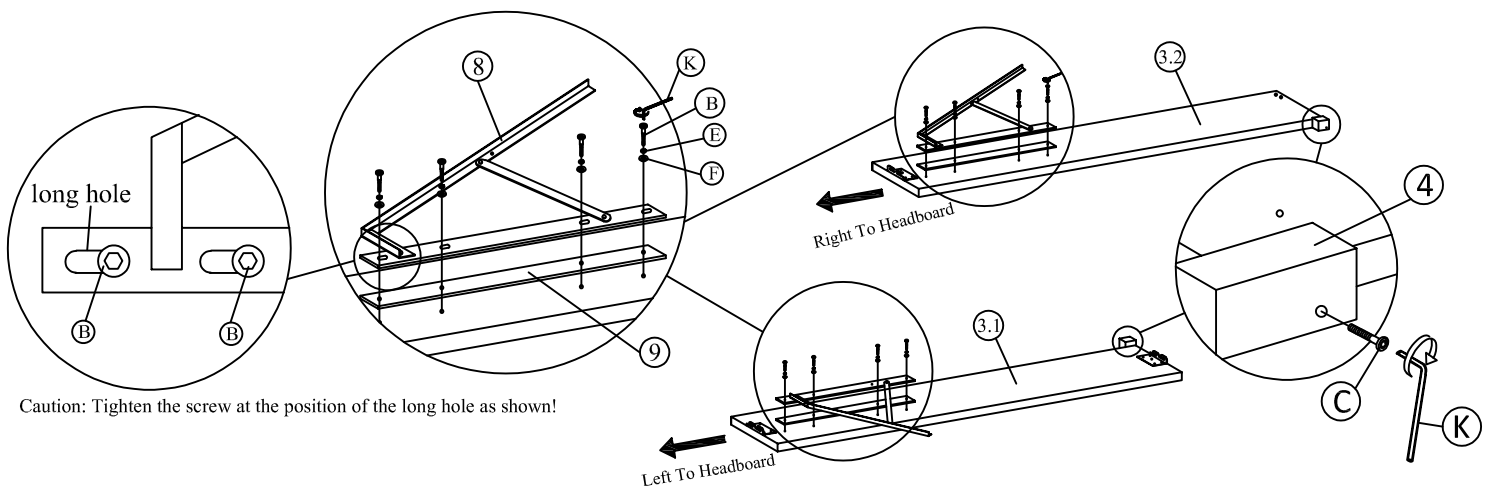

Assembly Instruction

Step 2 : Attach the Drawer Leg (15) to the bottom Footboard Drawer (16).
Marking on the wooden

Bottom View !!

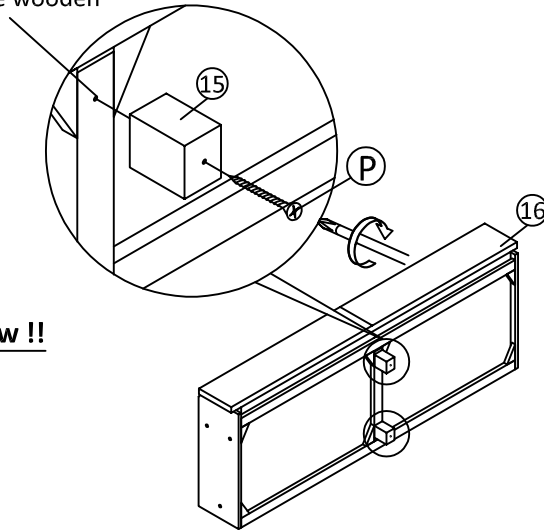

Step 3 : 3.1 Open the drawer out till its built-in stopping point.
3.2 Put the drawer frame on the side rail leg. Make sure the drawer side align to the side rail end.
3.3 Attach the drawer frame to the side rails by using the JCBC and Flat Washers.

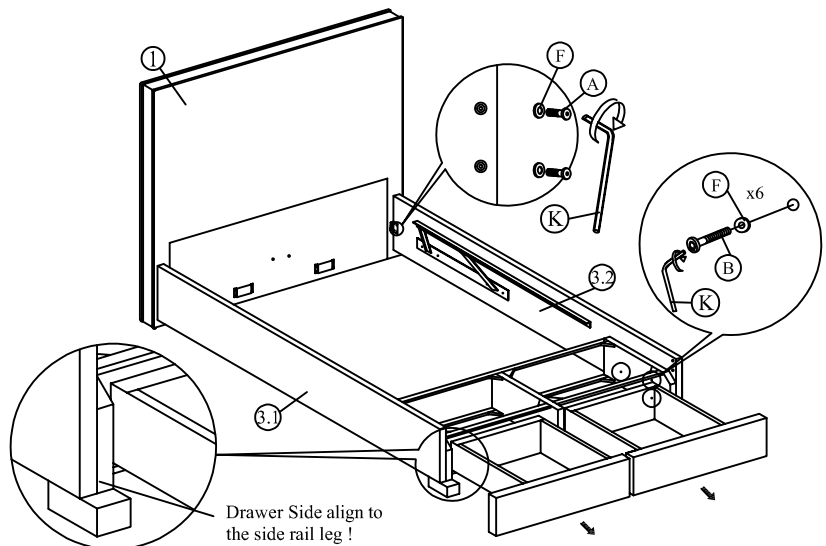

Step 4 : Attach the footboard (2) to side rails (3) by pushing the brackets down into place and secure the bolts using hardware part L as shown.

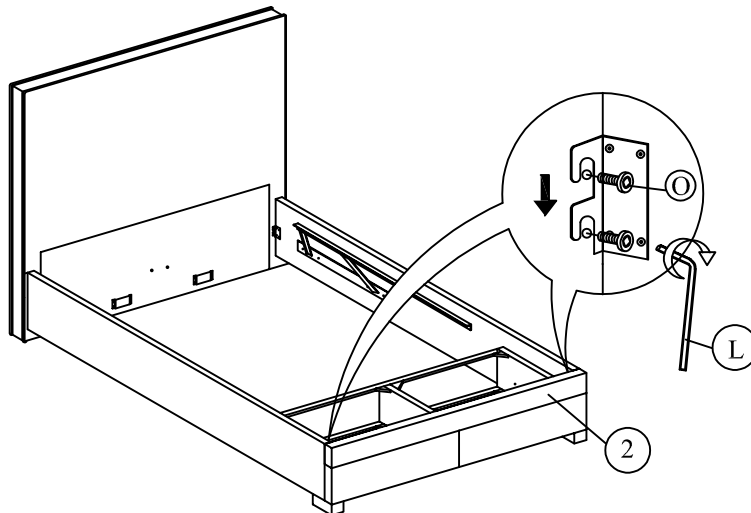

Assembly Instruction

Step 5 : Attach the support legs (7) to the centre rail (6) using hardware parts B and K.

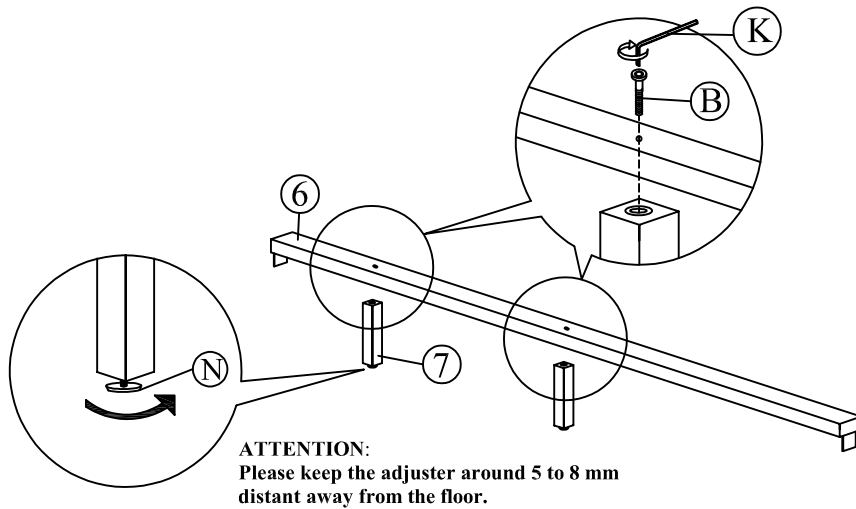

Step 6 : Insert the centre rail (6) to the headboard (1) and footboard (2).

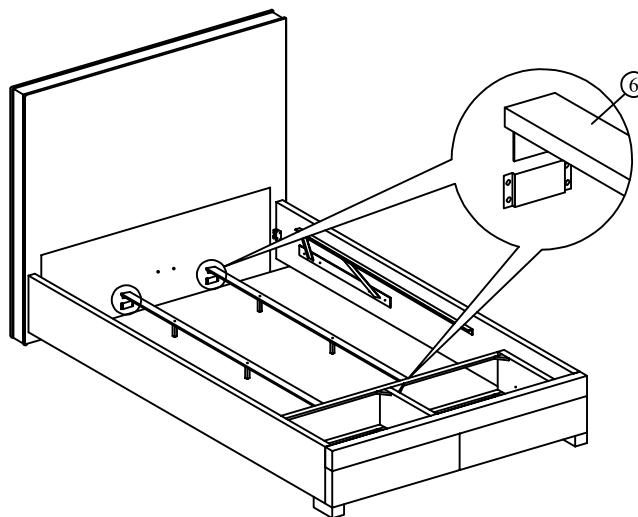

Step 7 : Insert the bottom panel (14) to the below frame.

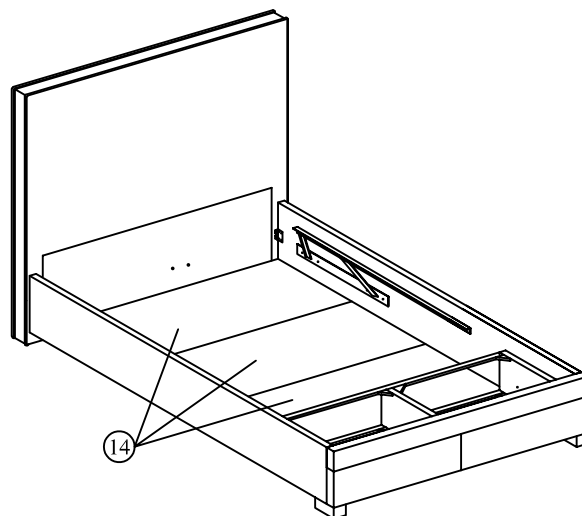

Assembly Instruction

Step 8 : Insert the centre rail (5) to the headend (1) and footend (2) and secure using hardware part A and K.

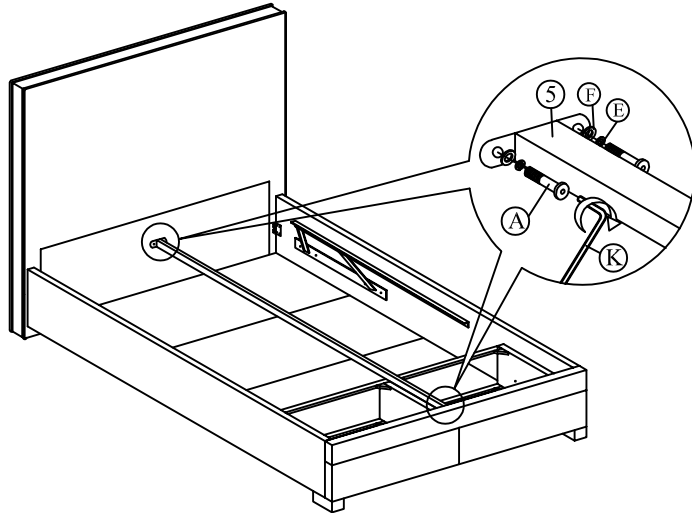

Step 9 : Unscrew the Pre-attached hex-nut of gas spring (10) and attach it back again as shown. Please fully tighten the nut.

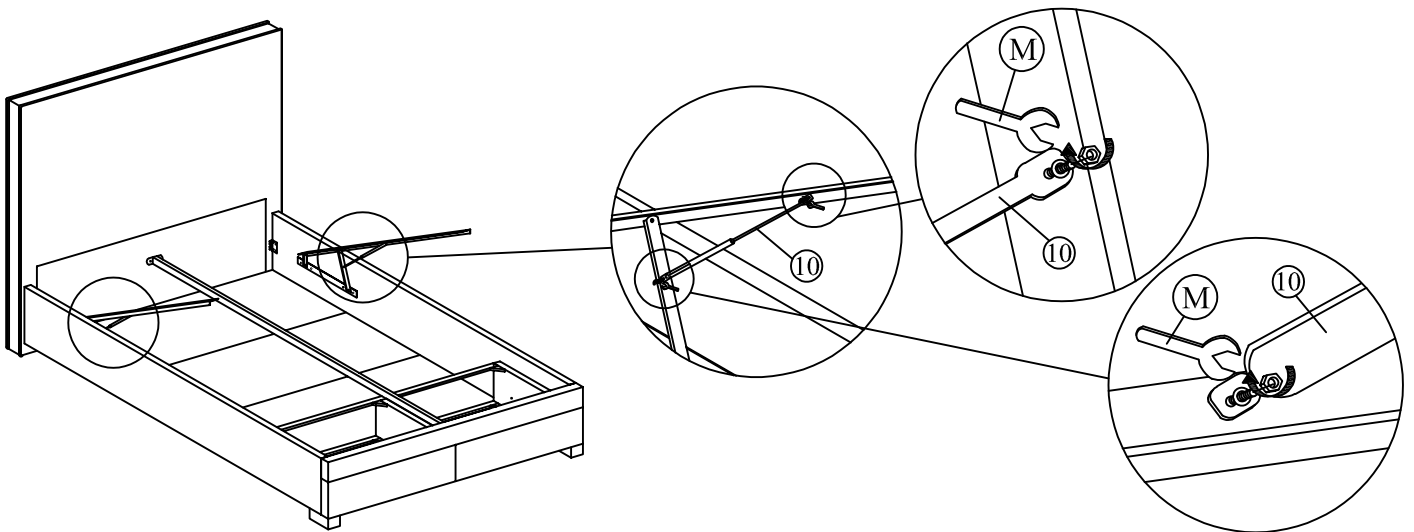

Assembly Instruction

Step 10 : Must place the wooden frame (12 & 13) in correct position (please follow the position as shown in diagram).

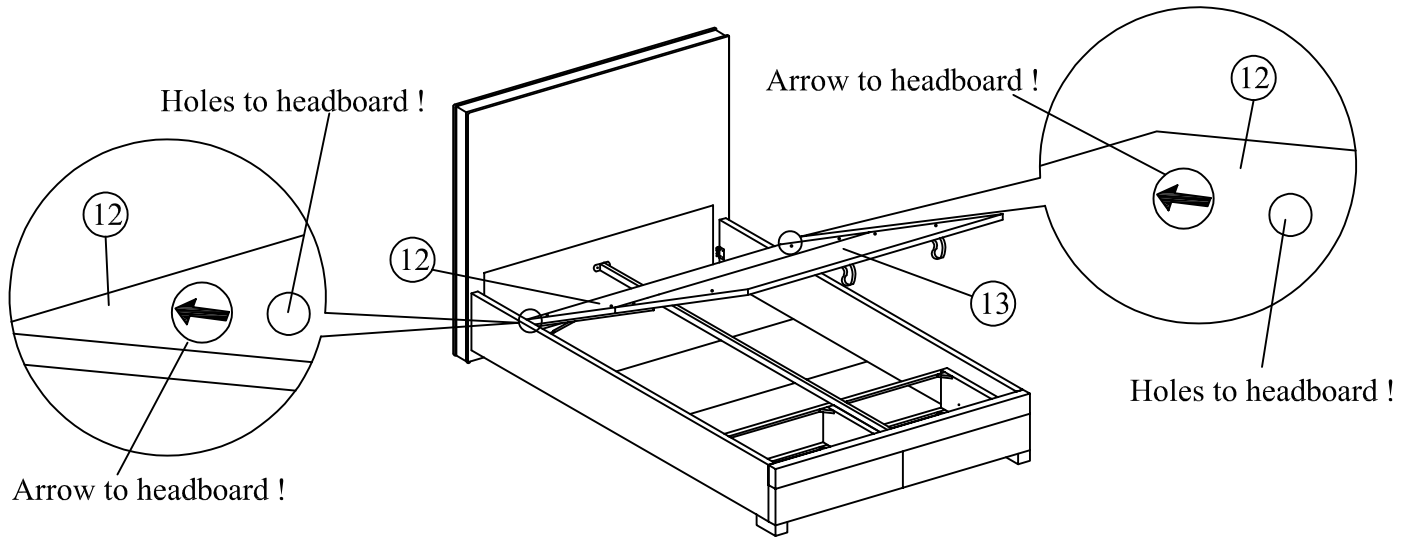

Step 11 : Assembly the wooden frame (12) and wooden frame (13) to the bracket and tighten all the fitting accordingly.

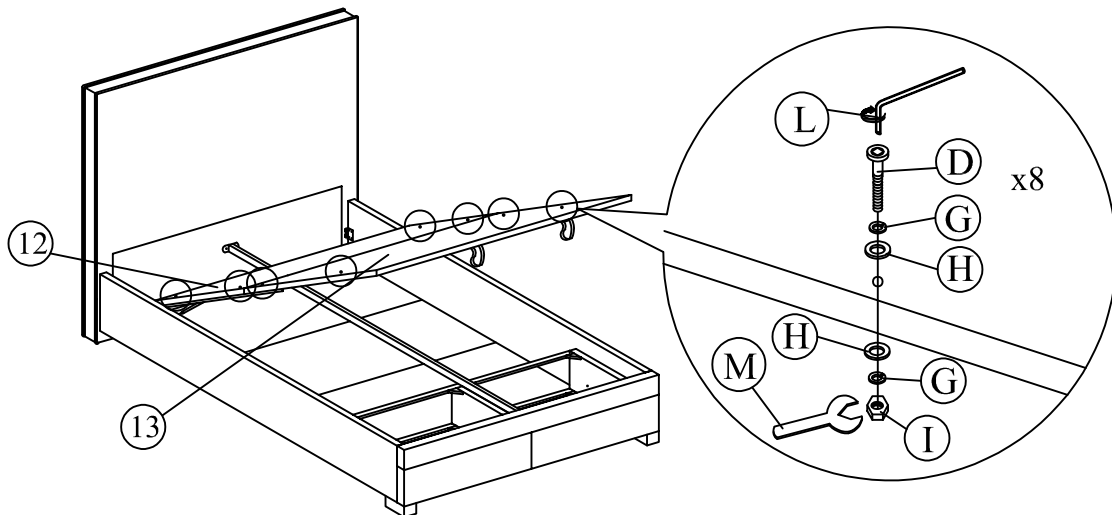

Assembly Instruction

Step 12 : Attach the wooden frame bracket (11) to the wooden frame using hardware parts J and a screwdriver (not provided).

Please follow the marking and attach the bracket accordingly

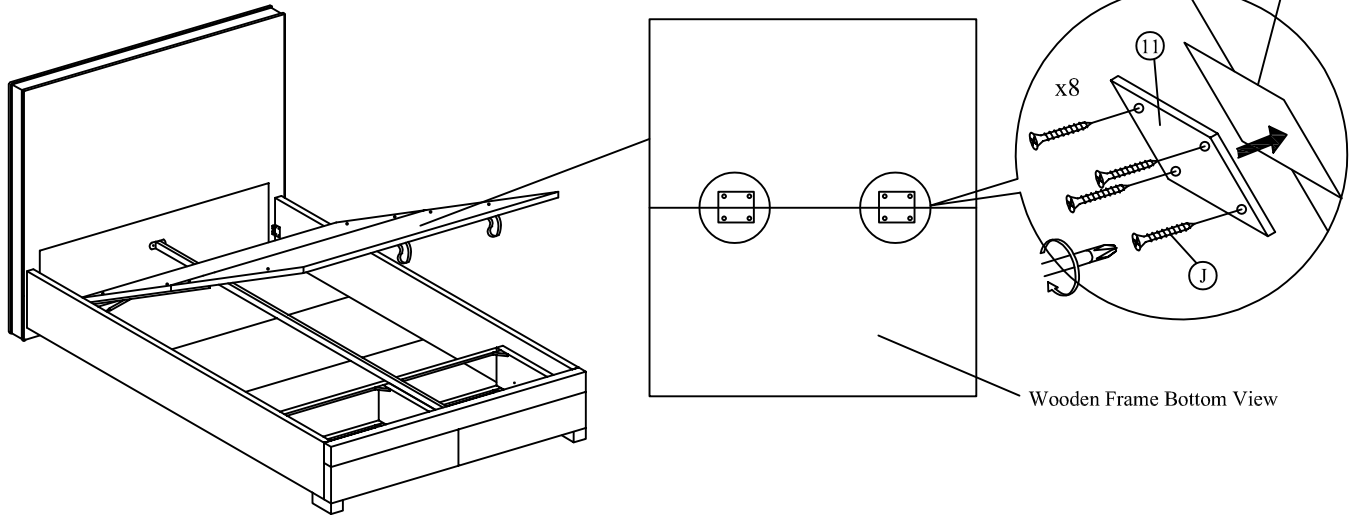

Step 13 : Please use the safety lock for safety purpose.

